

## Semion RFEA Systems

RETARDING FIELD ENERGY ANALYZERS FOR ION ENERGY AND FLUX MEASUREMENTS

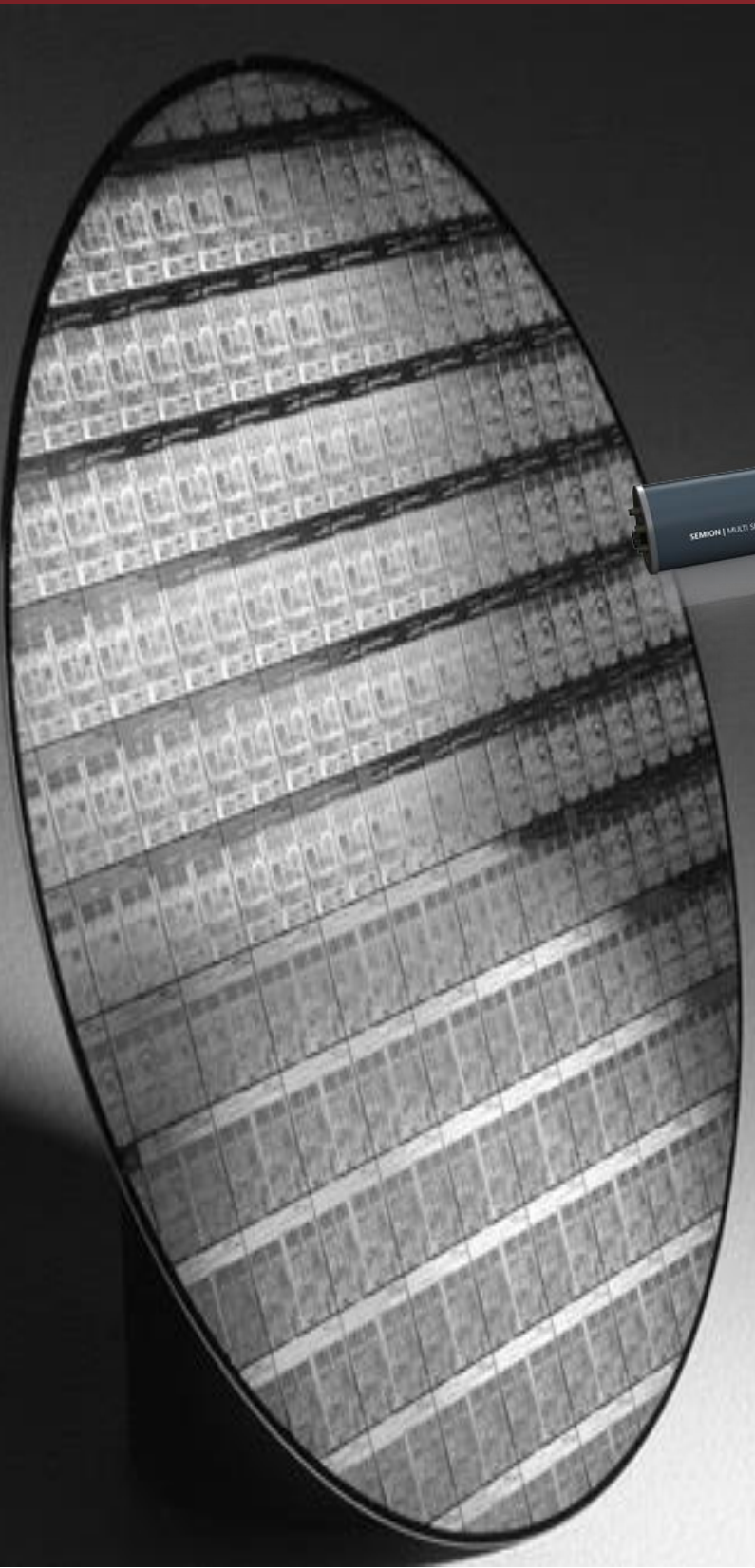

### Semion™

Retarding Field Energy Analyzers

#### Compatible Plasma Types

DC, Pulsed DC, RF, Pulsed RF & Microwave

#### Interchangeable Sensing Elements

Compatible with a wide range of plasma densities and gas pressures.

## Semion RFEA systems

The Semion retarding field energy analyzer product range provide a direct measurement of the ion energy distribution (IED) at the wafer surface (or any plasma facing surface) during plasma processing. The system was designed with RF and pulsed biasing capability. The system is comprised of an external data acquisition unit, an in-situ sensor and a vacuum-to-atmosphere feedthrough module. Single point and multi point sensor arrays are available. Spatiotemporal measurement of the variation in the ion energy distribution across a wide range of plasma process conditions is made possible by this state of the art measurement platform.

The Semion product range consists of the Semion pDC, Semion Single and Semion Multi models. This range ensures that there is a solution for almost every application. The Semion pDC system provides 44ns time resolution for pulsed plasmas up to 350 kHz. Semion Single allows for a small area sensor to be used and can be placed a different points

within the reactor. Under grounded conditions it can provide one microsecond time resolution for any pulsed plasma frequency. Semion Multi consists of a multi sensor array to measure process uniformity across the wafer surface. For grounded applications it can also provide one microsecond time resolution for each sensor.

### Key Features

- Single and multi-sensor options, mounted in a range of sensor holder sizes.
- Range of sensing elements available to cover a wide range of plasma density and pressure conditions.
- Up to 2000 eV ion energy measurement range.
- Time averaged, time trend and time resolved capabilities (application dependent).
- Displays IEDF profile, average energy, ion flux and DC bias voltage.
- Replaceable, low cost sensing elements with life time of 10s to 100s of measurements hours (process dependent).
- Sensor and sensor holder available in aluminium, anodized aluminium and stainless steel options.

### Key Benefits

- Portable, allowing measurements in multiple chambers.
- Easy to install, no chamber modifications needed.
- Provides live measurement of the IED under processing conditions.
- Multi sensor arrays provide contour maps of the process ion flux and energy uniformity.
- Provides insights for fundamental research and model validation.
- Generate process data for customer escalations and marketing material.
- Correlate process performance with the key plasma process drivers (ion energy and ion flux).
- Measures up to 1.5 Torr under certain conditions.

### Low Cost of Ownership

The Semion system was designed to have replaceable, low-cost sensing elements, each with a lifetime ranging from 10s to 100s of hours of plasma exposure. The other system components can be used repeatedly without the need for replacement. The sensor holder assembly is easily installed in (and uninstalled from) the processing chamber, making it convenient to move to other plasma tools as required.

### Cost Benefits

Enormous cost benefits can be achieved through the use of the Semion system. Process issues can be identified through direct measurement of the key process drivers in real time. This can be more effective than processing test wafers for offline analysis using costly metrology tools to examine etch or deposition rate uniformity, for example.

### Unparalleled Insight

The key process driver in the majority of plasma processes is the ion energy distribution arriving at the substrate. There are many sensors and instruments on the market to measure the various process inputs such as power, pressure and gas flow. These measurements provide no insight into what happens at the wafer other than from empirical models. There are also a range of instruments that measure parameters related to the bulk plasma conditions such as plasma density and electron temperature. While these are useful to know, a model of the plasma and sheath adjacent to the wafer is required to predict the ion energy and flux at the wafer. Direct measurement of the ion energy distribution at the wafer position provides the deepest process insight. The Semion system is the only instrument on the market that can provide this type of measurement across a broad range of plasma processing conditions.

### Smart Design for Ease of Use

While the theory of operation and the fine tuning of electrical potentials to be applied to the grid stack (that make up the sensing elements) can be complicated, the user friendly design of the Semion system makes it easy to use for all levels of expertise. Automated DC bias voltage measurement and associated grid potential configurations are carried out using smart algorithms. After minimal configuration, through the intuitive software user interface, an IEDF scan can be performed and results displayed to the user within seconds.

## Model Options

### Full Systems Options

Table 1: Semion System product family & availability

System Name	Supply Status	Spare Parts Availability			
		Sensor	Holder	Feedthrough	Controller
Semion 500	Obsolete	✗	✗	✗	✗
Semion 800	Obsolete	✓	✓	✓	✗
Semion 2500	Obsolete	✓	✓	✓	✗
Semion Single	Active	✓	✓	✓	✓
Semion Multi	Active	✓	✓	✓	✓
Semion HV	Active	✓	✓	✓	✓
Semion pDC	Active	✓	✓	✓	✓

### Control Unit Options

Table 2: Semion System – Controller Options

Part #	Product Name	Max. Scan Voltage Range <sup>1</sup>
02-0457-01	Semion Single   Electronics Unit   4 & 5 pin <sup>2</sup>	± 2000V DC
02-0458-01	Semion Single   Electronics Unit   17 pin <sup>3</sup>	± 2000V DC
02-0459-01	Semion Multi   Electronics Unit	± 2000V DC
02-0549-01	Semion pDC   Electronics Unit	± 2000V DC
02-0550-01	Semion HV   Electronics Unit	± 2000V DC



<sup>1</sup> Actual scan range is determined by systems components.

<sup>2</sup> Can be used as a stand-alone RFA controller and works with Semion 800/2500 system components.

<sup>3</sup> Compatible with Semion Single system components only.

## Feedthrough Options

Table 3: Semion System – Feedthrough Module Options

Part #	Product Name	Max. DC Withstanding Voltage
02-0453-01	Semion Single   Feedthrough   4 pin	± 1000V
02-0454-01	Semion Single   Feedthrough   5 pin	± 2000V
02-0455-01	Semion Single   Feedthrough   17 pin	± 2000V
02-0456-01	Semion Multi   Feedthrough	± 2000V
02-0547-01	Semion pDC   Feedthrough	± 2000V
02-0548-01	Semion HV   Feedthrough	± 2000V
02-0543-01	<sup>4</sup> Semion Single   Time-Resolved Feedthrough   4 pin	± 1000V
02-0544-01	<sup>4</sup> Semion Single   Time-Resolved Feedthrough   5 pin	± 2000V
02-0545-01	<sup>4</sup> Semion Single   Time-Resolved Feedthrough   17 pin	± 2000V
02-0546-01	<sup>4</sup> Semion Multi   Time-Resolved Feedthrough	± 2000V

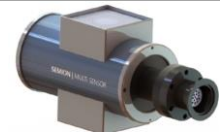

## Sensor Holder Options

Table 4: Semion 800 System – Single Sensor Holder Options<sup>5,6,7,8</sup>

Part #	Product Name	Material
02-0384-01	Single Holder   4-pin   Ø50 mm	Anodized Aluminium <sup>9</sup>
02-0385-01	Single Holder   4-pin   Ø50 mm	Aluminium
02-0386-01	Single Holder   4-pin   Ø50 mm	Stainless Steel
02-0393-01	Single Holder   4-pin   Ø70 mm	Anodized Aluminium
02-0394-01	Single Holder   4-pin   Ø70 mm	Aluminium
02-0395-01	Single Holder   4-pin   Ø70 mm	Stainless Steel
02-0402-01	Single Holder   4-pin   Ø100 mm	Anodized Aluminium
02-0403-01	Single Holder   4-pin   Ø100 mm	Aluminium
02-0404-01	Single Holder   4-pin   Ø100 mm	Stainless Steel
02-0414-01	Single Holder   4-pin   Ø150 mm	Anodized Aluminium
02-0415-01	Single Holder   4-pin   Ø150 mm	Aluminium
02-0416-01	Single Holder   4-pin   Ø150 mm	Stainless Steel
02-0426-01	Single Holder   4-pin   Ø200 mm	Anodized Aluminium
02-0427-01	Single Holder   4-pin   Ø200 mm	Aluminium
02-0428-01	Single Holder   4-pin   Ø200 mm	Stainless Steel
02-0438-01	Single Holder   4-pin   Ø300 mm	Anodized Aluminium
02-0439-01	Single Holder   4-pin   Ø300 mm	Aluminium
02-0440-01	Single Holder   4-pin   Ø300 mm	Stainless Steel

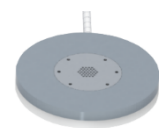

<sup>4</sup> Time resolved feedthroughs can only be operated when the sensor holder is connected to a grounded surface.

<sup>5</sup> The sensor holder is the carrier substrate plate that houses the replaceable sensing elements.

<sup>6</sup> All sensor holders are 5mm thick as standard.

<sup>7</sup> The Semion 800 single sensor holder has a ceramic-bead covered cable terminated with a 4-pin plug. Cable length to be specified at time or order.

<sup>8</sup> Semion 800 single sensor holders have a rated withstanding voltage of 1000V DC.

<sup>9</sup> All anodized sensor holders have an anodized layer thickness of 15 – 30 microns.

Table 5: Semion 2500 System – Single Sensor Holder Options<sup>10,11</sup>

Part #	Product Name	Material
02-0387-01	Single Holder   5-pin   Ø50 mm	Anodized Aluminium
02-0388-01	Single Holder   5-pin   Ø50 mm	Aluminium
02-0389-01	Single Holder   5-pin   Ø50 mm	Stainless Steel
02-0396-01	Single Holder   5-pin   Ø70 mm	Anodized Aluminium
02-0397-01	Single Holder   5-pin   Ø70 mm	Aluminium
02-0398-01	Single Holder   5-pin   Ø70 mm	Stainless Steel
02-0405-01	Single Holder   5-pin   Ø100 mm	Anodized Aluminium
02-0406-01	Single Holder   5-pin   Ø100 mm	Aluminium
02-0407-01	Single Holder   5-pin   Ø100 mm	Stainless Steel
02-0417-01	Single Holder   5-pin   Ø150 mm	Anodized Aluminium
02-0418-01	Single Holder   5-pin   Ø150 mm	Aluminium
02-0419-01	Single Holder   5-pin   Ø150 mm	Stainless Steel
02-0429-01	Single Holder   5-pin   Ø200 mm	Anodized Aluminium
02-0430-01	Single Holder   5-pin   Ø200 mm	Aluminium
02-0431-01	Single Holder   5-pin   Ø200 mm	Stainless Steel
02-0441-01	Single Holder   5-pin   Ø300 mm	Anodized Aluminium
02-0442-01	Single Holder   5-pin   Ø300 mm	Aluminium
02-0443-01	Single Holder   5-pin   Ø300 mm	Stainless Steel

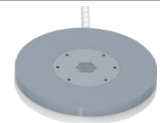

Table 6: Semion Single System – Single Sensor Holder Options<sup>12,13</sup>

Part #	Product Name	Material
02-0390-01	Single Holder   17-pin   Ø50 mm	Anodized Aluminium
02-0391-01	Single Holder   17-pin   Ø50 mm	Aluminium
02-0392-01	Single Holder   17-pin   Ø50 mm	Stainless Steel
02-0399-01	Single Holder   17-pin   Ø70 mm	Anodized Aluminium
02-0400-01	Single Holder   17-pin   Ø70 mm	Aluminium
02-0401-01	Single Holder   17-pin   Ø70 mm	Stainless Steel
02-0408-01	Single Holder   17-pin   Ø100 mm	Anodized Aluminium
02-0409-01	Single Holder   17-pin   Ø100 mm	Aluminium
02-0410-01	Single Holder   17-pin   Ø100 mm	Stainless Steel
02-0420-01	Single Holder   17-pin   Ø150 mm	Anodized Aluminium
02-0421-01	Single Holder   17-pin   Ø150 mm	Aluminium
02-0422-01	Single Holder   17-pin   Ø150 mm	Stainless Steel
02-0432-01	Single Holder   17-pin   Ø200 mm	Anodized Aluminium
02-0433-01	Single Holder   17-pin   Ø200 mm	Aluminium
02-0434-01	Single Holder   17-pin   Ø200 mm	Stainless Steel
02-0444-01	Single Holder   17-pin   Ø300 mm	Anodized Aluminium
02-0445-01	Single Holder   17-pin   Ø300 mm	Aluminium
02-0446-01	Single Holder   17-pin   Ø300 mm	Stainless Steel

<sup>10</sup> The Semion 2500 single sensor holders have a rated withstanding voltage of 2000V DC.

<sup>11</sup> The Semion 2500 single sensor holder has a ceramic-bead covered cable terminated with a 5-pin plug. Cable length to be specified at time or order.

<sup>12</sup> The Semion Single sensor holders have a rated withstanding voltage of 2000V DC.

<sup>13</sup> The Semion Single sensor holder has a ceramic-bead covered cable terminated with a 17-pin plug. Cable length to be specified at time or order.

Table 7: Semion Multi System – Multi Sensor Holder Options<sup>14,15</sup>

Part #	Product Name	Material	# Sensors
02-0411-01	Multi Holder   17-pin   Ø100 mm	Anodized Aluminium	4
02-0412-01	Multi Holder   17-pin   Ø100 mm	Aluminium	4
02-0413-01	Multi Holder   17-pin   Ø100 mm	Stainless Steel	4
02-0423-01	Multi Holder   17-pin   Ø150 mm	Anodized Aluminium	7
02-0424-01	Multi Holder   17-pin   Ø150 mm	Aluminium	7
02-0425-01	Multi Holder   17-pin   Ø150 mm	Stainless Steel	7
02-0435-01	Multi Holder   17-pin   Ø200 mm	Anodized Aluminium	9
02-0436-01	Multi Holder   17-pin   Ø200 mm	Aluminium	9
02-0437-01	Multi Holder   17-pin   Ø200 mm	Stainless Steel	9
02-0447-01	Multi Holder   17-pin   Ø300 mm	Anodized Aluminium	13
02-0448-01	Multi Holder   17-pin   Ø300 mm	Aluminium	13
02-0449-01	Multi Holder   17-pin   Ø300 mm	Stainless Steel	13
02-0450-01	Multi Holder   17-pin   Ø450 mm	Anodized Aluminium	13
02-0451-01	Multi Holder   17-pin   Ø450 mm	Aluminium	13
02-0452-01	Multi Holder   17-pin   Ø450 mm	Stainless Steel	13

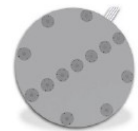

Table 8: Semion pDC System – Single Sensor Holder Options<sup>16,17</sup>

Part #	Product Name	Material
02-0528-01	Single Holder   pDC   Ø50 mm	Anodized Aluminium
02-0529-01	Single Holder   pDC   Ø50 mm	Aluminium
02-0530-01	Single Holder   pDC   Ø50 mm	Stainless Steel
02-XXXX-01	Single Holder   pDC   Ø70 mm	Anodized Aluminium
02-XXXX-01	Single Holder   pDC   Ø70 mm	Aluminium
02-XXXX-01	Single Holder   pDC   Ø70 mm	Stainless Steel
02-0531-01	Single Holder   pDC   Ø100 mm	Anodized Aluminium
02-0532-01	Single Holder   pDC   Ø100 mm	Aluminium
02-0533-01	Single Holder   pDC   Ø100 mm	Stainless Steel
02-0534-01	Single Holder   pDC   Ø150 mm	Anodized Aluminium
02-0535-01	Single Holder   pDC   Ø150 mm	Aluminium
02-0536-01	Single Holder   pDC   Ø150 mm	Stainless Steel
02-0537-01	Single Holder   pDC   Ø200 mm	Anodized Aluminium
02-0538-01	Single Holder   pDC   Ø200 mm	Aluminium
02-0539-01	Single Holder   pDC   Ø200 mm	Stainless Steel
02-0540-01	Single Holder   pDC   Ø300 mm	Anodized Aluminium
02-0541-01	Single Holder   pDC   Ø300 mm	Aluminium
02-0542-01	Single Holder   pDC   Ø300 mm	Stainless Steel

<sup>14</sup> The Semion Multi sensor holders have a rated withstanding voltage of 2000V DC.

<sup>15</sup> The Semion Multi sensor holder has a ceramic-bead covered cable terminated with a 17-pin plug. Cable length to be specified at time or order.

<sup>16</sup> The Semion pDC single sensor holders have a rated withstanding voltage of 2000V DC.

<sup>17</sup> The Semion pDC single sensor holder has a ceramic-bead covered cable terminated with 2 HV-BNC connectors. Cable length to be specified at time or order.

Table 9: Semion HV System – Single Sensor Holder Options<sup>18,19</sup>

Part #	Product Name	Material
02-0551-01	Single Holder   HV   Ø100 mm	Anodized Aluminium
02-0552-01	Single Holder   HV   Ø100 mm	Aluminium
02-0553-01	Single Holder   HV   Ø100 mm	Stainless Steel
02-0554-01	Single Holder   HV   Ø150 mm	Anodized Aluminium
02-0555-01	Single Holder   HV   Ø150 mm	Aluminium
02-0556-01	Single Holder   HV   Ø150 mm	Stainless Steel
02-0557-01	Single Holder   HV   Ø200 mm	Anodized Aluminium
02-0558-01	Single Holder   HV   Ø200 mm	Aluminium
02-0559-01	Single Holder   HV   Ø200 mm	Stainless Steel
02-0560-01	Single Holder   HV   Ø300 mm	Anodized Aluminium
02-0561-01	Single Holder   HV   Ø300 mm	Aluminium
02-0562-01	Single Holder   HV   Ø300 mm	Stainless Steel

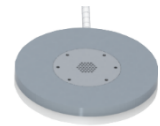

### Button Probe™ Sensing Element Options

Table 10: Semion 800 & Semion pDC – Button Probe Sensing Element Options<sup>20</sup>

Part #	Product Name
02-0339-01	Button Probe   Semion pDC/800   Anodized Aluminium   Standard Density
02-0342-01	Button Probe   Semion pDC/800   Anodized Aluminium   Low Density
02-0345-01	Button Probe   Semion pDC/800   Anodized Aluminium   High Density
02-0340-01	Button Probe   Semion pDC/800   Aluminium   Standard Density
02-0343-01	Button Probe   Semion pDC/800   Aluminium   Low Density
02-0346-01	Button Probe   Semion pDC/800   Aluminium   High Density
02-0341-01	Button Probe   Semion pDC/800   Stainless Steel   Standard Density
02-0344-01	Button Probe   Semion pDC/800   Stainless Steel   Low Density
02-0347-01	Button Probe   Semion pDC/800   Stainless Steel   High Density

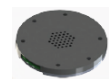

<sup>18</sup> The Semion HV single sensor holders have a rated withstanding voltage of 3000V DC.

<sup>19</sup> The Semion HV single sensor holder has a ceramic-bead covered cable terminated with 5-pin plug. Cable length to be specified at time or order.

<sup>20</sup> Operating pressure ≤ 300 mTorr



Table 11: Semion 2500, Semion Single & Semion Multi – Button Probe Sensing Element Options

Part #	Product Name
02-0007-03	Button Probe   Semion 2500   Anodized Aluminium   Standard Density   ≤ 300 mTorr
02-0333-01	Button Probe   Semion 2500   Anodized Aluminium   Low Density   ≤ 300 mTorr
02-0336-01	Button Probe   Semion 2500   Anodized Aluminium   High Density   ≤ 300 mTorr
02-0375-01	Button Probe   Semion 2500   Anodized Aluminium   Standard Density   ≤ 1.5 Torr
02-0378-01	Button Probe   Semion 2500   Anodized Aluminium   Low Density   ≤ 1.5 Torr
02-0381-01	Button Probe   Semion 2500   Anodized Aluminium   High Density   ≤ 1.5 Torr
02-0331-01	Button Probe   Semion 2500   Aluminium   Standard Density   ≤ 300 mTorr
02-0334-01	Button Probe   Semion 2500   Aluminium   Low Density   ≤ 300 mTorr
02-0337-01	Button Probe   Semion 2500   Aluminium   High Density   ≤ 300 mTorr
02-0376-01	Button Probe   Semion 2500   Aluminium   Standard Density   ≤ 1.5 Torr
02-0379-01	Button Probe   Semion 2500   Aluminium   Low Density   ≤ 1.5 Torr
02-0382-01	Button Probe   Semion 2500   Aluminium   High Density   ≤ 1.5 Torr
02-0332-01	Button Probe   Semion 2500   Stainless Steel   Standard Density   ≤ 300 mTorr
02-0335-01	Button Probe   Semion 2500   Stainless Steel   Low Density   ≤ 300 mTorr
02-0338-01	Button Probe   Semion 2500   Stainless Steel   High Density   ≤ 300 mTorr
02-0377-01	Button Probe   Semion 2500   Stainless Steel   Standard Density   ≤ 1.5 Torr
02-0380-01	Button Probe   Semion 2500   Stainless Steel   Low Density   ≤ 1.5 Torr
02-0383-01	Button Probe   Semion 2500   Stainless Steel   High Density   ≤ 1.5 Torr

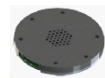
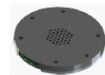

Table 12: Semion HV – Button Probe Sensing Element Options

Part #	Product Name
02-0366-01	Button Probe   Semion 3kV   Anodized Aluminium   Standard Density   ≤ 300 mTorr
02-0369-01	Button Probe   Semion 3kV   Anodized Aluminium   Low Density   ≤ 300 mTorr
02-0372-01	Button Probe   Semion 3kV   Anodized Aluminium   High Density   ≤ 300 mTorr
02-0367-01	Button Probe   Semion 3kV   Aluminium   Standard Density   ≤ 300 mTorr
02-0370-01	Button Probe   Semion 3kV   Aluminium   Low Density   ≤ 300 mTorr
02-0373-01	Button Probe   Semion 3kV   Aluminium   High Density   ≤ 300 mTorr
02-0368-01	Button Probe   Semion 3kV   Stainless Steel   Standard Density   ≤ 300 mTorr
02-0371-01	Button Probe   Semion 3kV   Stainless Steel   Low Density   ≤ 300 mTorr
02-0374-01	Button Probe   Semion 3kV   Stainless Steel   High Density   ≤ 300 mTorr



## Parameters Reported

Table 13: Parameters Reported by Semion Systems.

Parameters measured by the Semion product family	
Parameters Displayed	Description
<b>Semion 500/800/2500/pDC/HV</b>	
IV Curve [Time Averaged   Time Resolved <sup>21</sup> ]	Current v. Voltage Curve
IEDF [Time Averaged   Time Resolved <sup>21</sup> ]	Ion Energy Distribution Function
J <sub>I</sub> [Time Averaged   Time Resolved <sup>21</sup> ]	Ion Flux
<b>Semion Single</b>	
IV Curve [Time Averaged   Time Trend   Time Resolved <sup>22</sup> ]	Current v. Voltage Curve
IEDF [Time Averaged   Time Trend   Time Resolved <sup>22</sup> ]	Ion Energy Distribution Function
J <sub>I</sub> [Time Averaged   Time Trend   Time Resolved <sup>22</sup> ]	Ion Flux
<E> [Time Averaged   Time Trend   Time Resolved <sup>22</sup> ]	Average Energy
Vdc [Time Averaged   Time Trend   Time Resolved <sup>22</sup> ]	Time Averaged Electrode Voltage
<b>Semion Multi</b>	
IV Curve [Time Averaged   Time Trend   Time Resolved <sup>23</sup> ]	Current v. Voltage Curve For Each Sensor
IEDF [Time Averaged   Time Trend   Time Resolved <sup>23</sup> ]	Ion Energy Distribution Function For Each Sensor
J <sub>I</sub> [Time Averaged   Time Trend   Time Resolved <sup>23</sup> ]	Ion Flux For Each Sensor
<E> [Time Averaged   Time Trend   Time Resolved <sup>23</sup> ]	Average Energy For Each Sensor
Vdc [Time Averaged   Time Trend   Time Resolved <sup>23</sup> ]	Time Averaged Electrode Voltage
J <sub>I</sub> & <E> [Time Averaged   Time Trend   Time Resolved <sup>23</sup> ]	Contour Map

<sup>21</sup> Semion 500/800/2500/HV require a time resolved feedthrough and sensor must be mounted on a grounded surface.

<sup>22</sup> Semion Single requires a time resolved feedthrough and sensor must be mounted on a grounded surface.

<sup>23</sup> Semion Multi requires a time resolved feedthrough and sensor must be mounted on a grounded surface.

## Specifications

### Controller Specifications

Table 14: General Controller Specifications

Controller <sup>24</sup> Environmental Specifications	
Mains voltage	100 – 240 V AC
Mains Current	1.6 A AC
Mains frequency	47 – 63 Hz
Installation category	II
Pollution degree	1
Max. relative humidity	95%, non-condensing
Max. operating temperature	55° C
Max. altitude	3000 meters
Protection rating	IP20 (IEC 60529)

Table 15: Semion Single (4 & 5 pin model) & HV Controller Specifications

Controller Operating Specifications	
# Voltage Channels	4 (G1/G2/G3/C)
Voltage Scan Range	-2000 V to +2000 V per channel
Max. Current	±1 mA per channel
Connectivity	USB 2.0
PC Operating System	Windows XP / 7 / 8 / 10
Sampling Rate	1 MS/s
Data Acquisition Resolution	16 bit
Time Resolved Step Resolution	1 μs
External Sync (for time resolved mode)	TTL
Synchronization frequency range	4 Hz to 100 kHz
Electrical Connections	4x HV BNC connectors

<sup>24</sup> All Semion controller models.

Table 16: Semion Single &amp; Multi Controller Specifications (17 pin models)

Controller Operating Specifications	
# Voltage Channels	3 (G2/G3/C) <sup>25</sup>
Voltage Scan Range	-2000 V to +2000 V per channel
Current Range	±1 mA per channel
Connectivity	USB 2.0
PC Operating System	Windows XP / 7 / 8 / 10
Sampling Rate	1 MS/s
Data Acquisition Resolution	16 bit
Time Resolved Step Resolution	1 µs
External Sync (for time resolved mode)	TTL
Synchronization frequency range	4 Hz to 100 KHz
Electrical Connections	3x HV BNC connectors

Table 17: Semion pDC Controller Specifications

Controller Operating Specifications	
# Voltage Channels	3 (G1/G2/C) <sup>26</sup>
Voltage Scan Range	-2000 V to +2000 V per channel
Current Range	±1 mA per channel
Connectivity	USB 2.0
PC Operating System	Windows XP / 7 / 8 / 10
Sampling Rate	22 MS/s
Data Acquisition Resolution	16 bit
Time Resolved Step Resolution	45 ns
External Sync (for time resolved mode)	TTL
Synchronization frequency range	4 Hz to 350 KHz
Electrical Connections	3x HV BNC connectors

<sup>25</sup> G1 voltage is generated in the feedthrough module.

<sup>26</sup> Semion pDC is designed to work with a three grid retarding field analyser only.

## Feedthrough Module Specifications

Table 18: Semion 800 Feedthrough Module Specifications

Feedthrough Module Specifications	
# Voltage I/O Channels (Airside)	3 input (G1/G2/C), 1 output (G0)
DC Withstanding Voltage	1000 V for each channel
Max. Current <sup>27</sup>	±60 µA per channel
Electrical Connections (Airside)	3x HV BNC connectors
Connectivity	HV cables to controller, no digital output
Sensor DC Voltage Measurement	Requires voltmeter connected to G0 port
Vacuum Flange Options	KF40, CF40
Vacuum Side Interface	Ceramic tube (∅13 mm) with 4 pin socket
With RF Filter Module	
Frequency Range	400 kHz – 60 MHz
Max. RF Bias Voltage (Applied to Sensor)	800 V peak-to-peak
With Time Resolved Module	
Time Resolution	5 µs
Sensor Bias Conditions	Grounded only

Table 19: Semion 2500 Feedthrough Module Specifications

Feedthrough Module Specifications	
# Voltage I/O Channels (Airside)	4 input (G1/G2/G3/C), 1 output (G0)
DC Withstanding Voltage	3000 V for each channel
Max. Current <sup>27</sup>	±60 µA per channel
Electrical Connections (Airside)	4x HV BNC connectors
Connectivity	HV cables to controller, no digital output
Sensor DC Voltage Measurement	Requires voltmeter connected to G0 port
Vacuum Flange Options	KF40, CF40
Vacuum Side Interface	Ceramic tube (∅25 mm) with 5 pin socket
With RF Filter Module	
Frequency Range	400 kHz – 60 MHz
Max. RF Bias Voltage (Applied to Sensor)	1000 V peak-to-peak
With Time Resolved Module	
Time Resolution	5 µs
Sensor Bias Conditions	Grounded only

<sup>27</sup> Limited by the filter network, not the controller power supplies.

Table 20: Semion Single &amp; Multi Feedthrough Module Specifications

Feedthrough Module Specifications	
# Voltage I/O Channels (Airside)	3 input (G2/G3/C)
DC Withstanding Voltage	3000 V for each channel
Max. Current <sup>27</sup>	±60 µA per channel
Electrical Connections (Airside)	3x HV BNC connectors
Connectivity	HV cables to controller, Ethernet cable to controller
Sensor DC Voltage Measurement	Measured internally
Vacuum Flange Options	KF40, CF40
Vacuum Side Interface	Ceramic tube (Ø25 mm) with 17 pin socket
With RF Filter Module	
Frequency Range	100 kHz – 100 MHz
Max. RF Bias Voltage (Applied to Sensor)	1000 V peak-to-peak
With Time Resolved Module	
Time Resolution	5 µs
Sensor Bias Conditions	Grounded only

Table 21: Semion pDC Feedthrough Module Specifications

Feedthrough Module Specifications	
# Voltage I/O Channels (Airside)	3 input (G1/G2/C), 1 output (G0)
DC Withstanding Voltage	3000 V for each channel
Max. Current <sup>27</sup>	±60 µA per channel
Electrical Connections (Airside)	3x HV BNC connectors
Connectivity	HV cables to controller, Ethernet cables to controller
Sensor DC Voltage Measurement	Requires voltmeter connected to G0 port
Vacuum Flange Options	KF40
Vacuum Side Interface	2x Floating Shield SHV connectors
Frequency Range	1 kHz – 350 kHz
Max. pDC Bias Voltage (Applied to Sensor)	400 V peak-to-peak
Time Resolution	44 ns

Table 22: Semion HV Feedthrough Module Specifications

Feedthrough Module Specifications	
# Voltage I/O Channels (Airside)	4 input (G1/G2/G3/C), 1 output (G0)
DC Withstanding Voltage	3000 V for each channel
Max. Current <sup>27</sup>	±60 µA per channel
Electrical Connections (Airside)	4x HV BNC connectors
Connectivity	HV cables to controller, Ethernet cables to controller
Sensor DC Voltage Measurement	Requires voltmeter connected to G0 port
Vacuum Flange Options	KF40, CF40
Vacuum Side Interface	Ceramic tube (Ø25 mm) with 5 pin socket
With RF Filter Module	
Frequency Range	400 kHz – 60 MHz
Max. RF Bias Voltage (Applied to Sensor)	3000 V peak-to-peak (≤ 13.56MHz)
With Time Resolved Module	
Time Resolution	5 µs
Sensor Bias Conditions	Grounded only

### Sensor Holder Specifications

Table 23: Semion 800 – Single Sensor Holder Specifications

Single Sensor Holder Specifications	
Holder Diameter	50/70/100/150/200/300 mm
Holder Thickness	5 mm
Holder Material	Aluminium/Anodized Aluminium/Stainless Steel
Protective Cable Shielding	Ceramic fish-spine beading
Cable OD	5 mm
Cable Length	650 mm standard, customizable to several meters
Cable Bend Radius	20 mm
Cable Plug	Proprietary 4 pin plug
Button Probe Receiver Pocket OD	33 mm
Button Probe Fixings	2x M2x5 mm countersunk screws
Max. operating temperature	150° C

Table 24: Semion 2500 – Single Sensor Holder Specifications

Single Sensor Holder Specifications	
Holder Diameter	50/70/100/150/200/300 mm
Holder Thickness	5 mm
Holder Material	Aluminium/Anodized Aluminium/Stainless Steel
Protective Cable Shielding	Ceramic fish-spine beading
Cable OD	5 mm
Cable Length	650 mm standard, customizable to several meters
Cable Bend Radius	20 mm
Cable Plug	Proprietary 5 pin plug
Button Probe Receiver Pocket OD	33 mm
Button Probe Fixings	2x M2x5 mm countersunk screws
Max. operating temperature	150° C

Table 25: Semion Single – Single Sensor Holder Specifications

Single Sensor Holder Specifications	
Holder Diameter	50/70/100/150/200/300 mm
Holder Thickness	5 mm
Holder Material	Aluminium/Anodized Aluminium/Stainless Steel
Protective Cable Shielding	Ceramic fish-spine beading
Cable OD	5 mm
Cable Length	650 mm standard, customizable to several meters
Cable Bend Radius	20 mm
Cable Plug	Proprietary 17 pin plug
Button Probe Receiver Pocket OD	33 mm
Button Probe Fixings	2x M2x5 mm countersunk screws
Max. operating temperature	150° C



Table 26: Semion pDC – Single Sensor Holder Specifications

Single Sensor Holder Specifications	
Holder Diameter	50/70/100/150/200/300 mm
Holder Thickness	5 mm
Holder Material	Aluminium/Anodized Aluminium/Stainless Steel
Protective Cable Shielding	Ceramic fish-spine beading
Cable OD	7 mm
Cable Length	650 mm standard, customizable to several meters
Cable Bend Radius	30 mm
Cable Plug	2x SHV male connectors
Button Probe Receiver Pocket OD	33 mm
Button Probe Fixings	2x M2x5 mm countersunk screws
Max. operating temperature	150° C

Table 27: Semion HV – Single Sensor Holder Specifications

Single Sensor Holder Specifications	
Holder Diameter	100/150/200/300 mm
Holder Thickness	5 mm
Holder Material	Aluminium/Anodized Aluminium/Stainless Steel
Protective Cable Shielding	Ceramic fish-spine beading
Cable OD	13 mm
Cable Length	650 mm standard, customizable to several meters
Cable Bend Radius	50 mm
Cable Plug	Proprietary 5 pin plug
Button Probe Receiver Pocket OD	33 mm
Button Probe Fixings	2x M2x5 mm countersunk screws
Max. operating temperature	150° C

Table 28: Semion Multi – Multi Sensor Holder Specifications

Single Sensor Holder Specifications	
Holder Diameter	100/150/200/300/450 mm
# Button Probes	4/7/9/13/13 respectively
Holder Thickness	5 mm
Holder Material	Aluminium/Anodized Aluminium/Stainless Steel
Protective Cable Shielding	Ceramic fish-spine beading
Cable OD	See drawing
Cable Length	650 mm standard, customizable to several meters
Cable Bend Radius	50 mm
Cable Plug	Proprietary 17 pin plug
Button Probe Receiver Pocket OD	33 mm
Button Probe Fixings	2x M2x5 mm countersunk screws
Max. operating temperature	150° C

### Button Probe – Sensing Element Specifications

Table 29: Semion 800 & pDC – Button Probe Specifications

Sensing Element Specifications	
Button Probe Diameter	33 mm
Button Probes Thickness	3.2 mm
Button Probe Material	Aluminium/Anodized Aluminium/Stainless Steel
# Sensing Apertures	1/7/37 [low/high/standard density respectively]
Aperture Diameter	10/0.5/0.8 mm [low/high/standard density respectively]
# Grids	3 (G0/G1/G2) & 1 Collector
Grid Hole Size	25 x 25 microns (square holes)
Grid Transparency	54% (High/Standard density), 70% (Low density)
Pressure Range Options	≤ 300 mTorr (≤ 800 eV) & ≤ 1.5 Torr (≤ 150 eV)
Ion Flux Conversion Factors	3.71e4/4.62e6/3.41e5 [low/high/standard density respectively]
Button Probe Fixings	2x M2 threaded screw holes
Max. operating temperature	150° C
DC Withstanding Voltage	1000 V (≤ 300 mTorr), 150 V (≤ 1.5 Torr)

Table 30: Semion Single/Multi/2500 – Button Probe Specifications

Sensing Element Specifications	
Button Probe Diameter	33 mm
Button Probes Thickness	3.2 mm
Button Probe Material	Aluminium/Anodized Aluminium/Stainless Steel
# Sensing Apertures	1/7/37 [low/high/standard density respectively]
Aperture Diameter	10/0.5/0.8 mm [low/high/standard density respectively]
# Grids	4 (G0/G1/G2/G3) & 1 Collector
Grid Hole Size	25 x 25 microns (square holes)
Grid Transparency	54% (High/Standard density), 70% (Low density)
Pressure Range Options	≤ 300 mTorr (≤ 1500 eV) & ≤ 1.5 Torr (≤ 150 eV)
Ion Flux Conversion Factors	5.30e4/8.56e6/6.32e5 [low/high/standard density respectively]
Button Probe Fixings	2x M2 threaded screw holes
Max. operating temperature	150° C
DC Withstanding Voltage	1500 V (≤ 300 mTorr), 150 V (≤ 1.5 Torr)

Table 31: Semion HV – Button Probe Specifications

Sensing Element Specifications	
Button Probe Diameter	35 mm
Button Probes Thickness	3.2 mm
Button Probe Material	Aluminium/Anodized Aluminium/Stainless Steel
# Sensing Apertures	1/7/37 [low/high/standard density respectively]
Aperture Diameter	10/0.5/0.8 mm [low/high/standard density respectively]
# Grids	4 (G0/G1/G2/G3) & 1 Collector
Grid Hole Size	25 x 25 microns (square holes)
Grid Transparency	54% (High/Standard density), 70% (Low density)
Pressure Range Options	≤ 100 mTorr (≤ 3000 eV) & ≤ 1.5 Torr (≤ 150 eV)
Ion Flux Conversion Factors	5.30e4/8.56e6/6.32e5 [low/high/standard density respectively]
Button Probe Fixings	2x M2 threaded screw holes
Max. operating temperature	150° C
DC Withstanding Voltage	3000 V (≤ 100 mTorr), 150 V (≤ 1.5 Torr)

## Dimensional Drawings

### *Semion Controller*

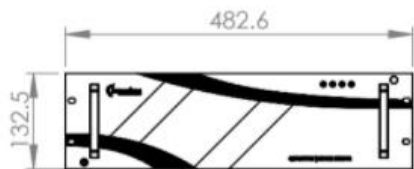

Front View

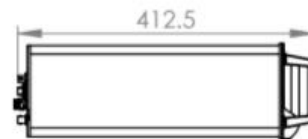

Side View



Plan View



Isometric View

*Figure 1: Dimensional drawings of the Semion controller. All dimensions are in mm. Form factor and outer dimensions are the same for all Semion controller models.*

**Semion Feedthrough | 17 Pin Models**

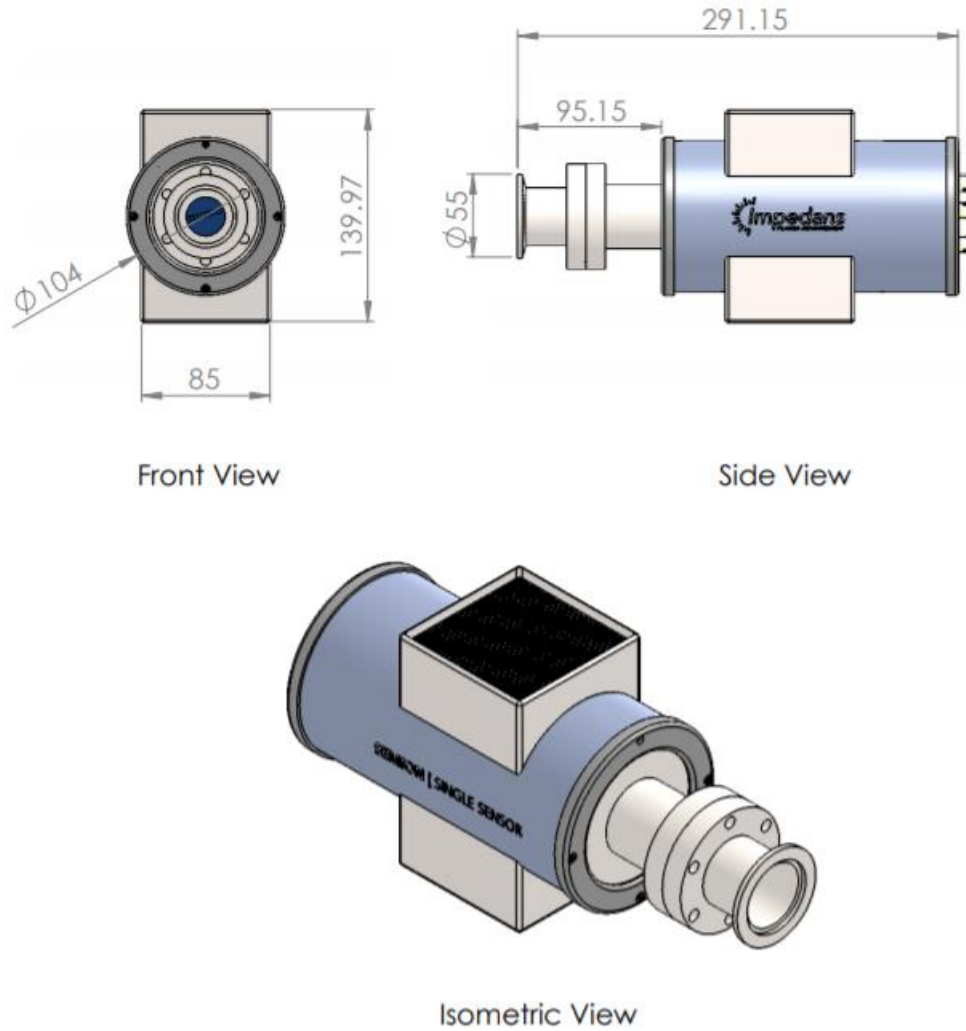

Figure 2: Dimensional drawings of the Semion feedthrough, 17 pin model. It shows an optional CF-to-KF adapter. All dimensions are in mm. Form factor and outer dimensions are the same for all Semion feedthrough models, except the 4 & 5 pin versions.

### Semion Single Sensor Holders | 17 Pin Models

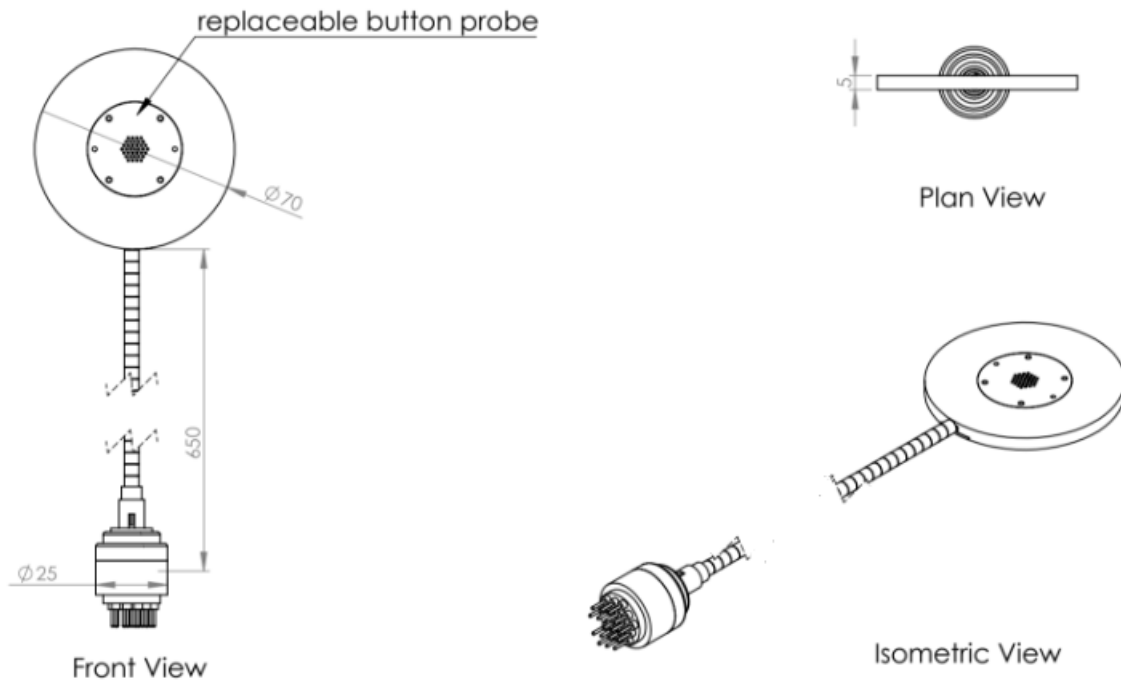

Figure 3: Dimensional drawings of a 70 mm diameter Semion Single sensor holder with 17 pin plug. All dimensions are in mm. The cable length can be specified at the time of order. Drawing for other models available on request.

### Semion Multi Sensor Holders

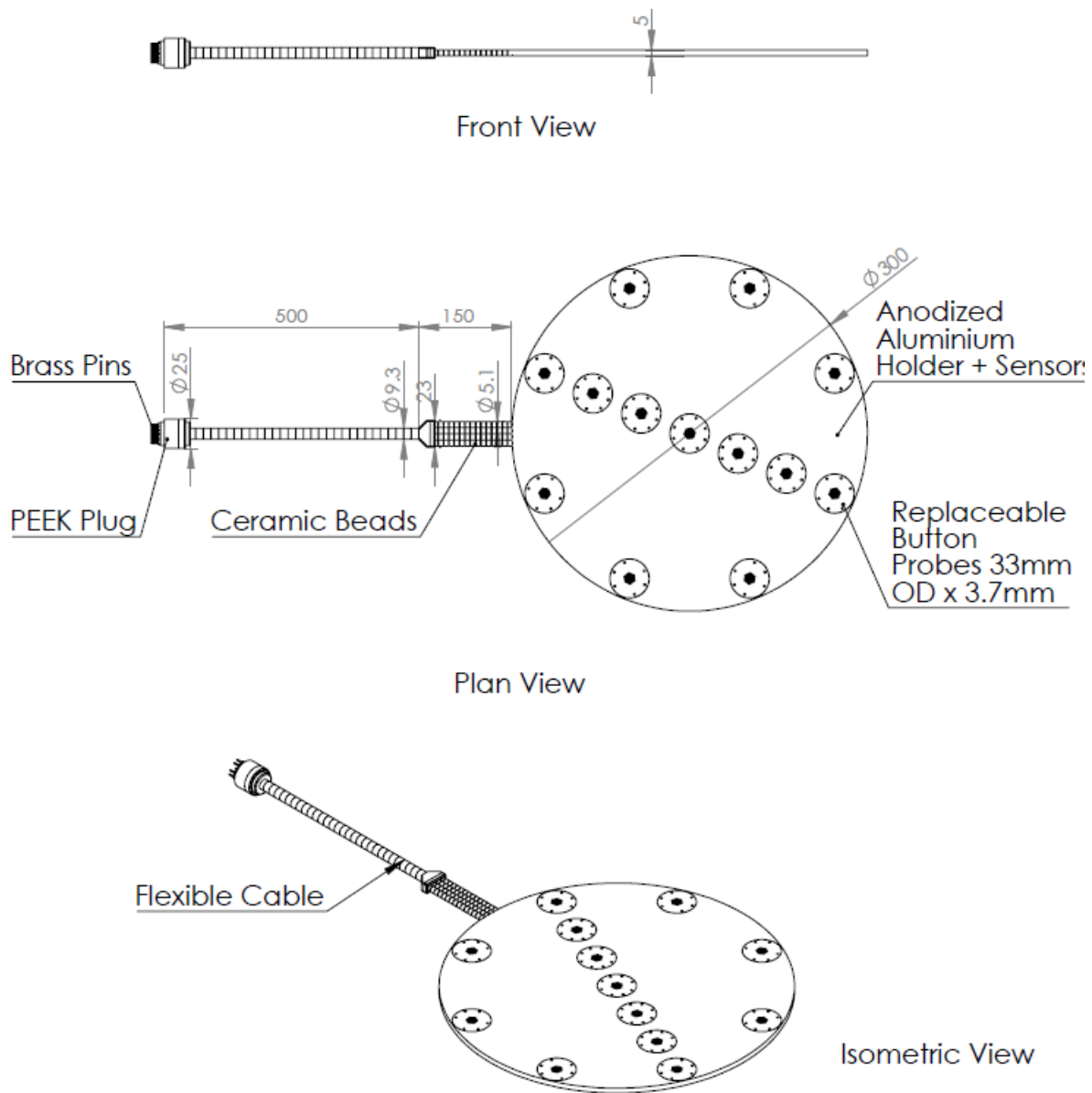

Figure 4: Dimensional drawings of a 300 mm diameter, 13 sensor, Semion Multi holder with 17 pin plug. All dimensions are in mm. The cable length can be specified at the time of order. Drawing for other models available on request.

## Software Screenshots

