

Octiv™ Suite 2.0

RF Voltage and Current Sensors



For your RF plasma measurement and control applications







Harmonic frequency spectrum, ion flux and waveform analysis

The Octiv Suite 2.0 VI probe is the most advanced RF sensor on the market for in-line power and impedance measurement with unrivalled accuracy and functionality. With 1% true accuracy, chamber-to-chamber matching and process repeatability can be established with confidence. This sensor is designed for advanced R&D and live process monitoring. It combines the pulse monitoring features of the Octiv Mono and the harmonic spectrum capabilities of the Octiv Poly with advanced functionality such as reconstruction of the time domain RF voltage and current waveform, using proprietary harmonic phase deconvolution techniques in the digitization process, making real time monitoring of the ion flux possible when mounted in-line with the process substrate. Uniquely, this sensor allows the process electrode to be employed in a secondary role as a planar Langmuir probe, enabling plasma density and electron temperature determination.

Key Features

-  Choice of 5 frequencies on a single sensor, measures multiple frequencies simultaneously.
-  Unrivalled accuracy into 50 Ω and non-50 Ω impedances through our advanced calibration methodology.
-  Sensor run-to-run repeatability (<0.1%) enables a true gauge of plasma process drift.
-  Single and multi-frequency voltage and current waveform display.
-  Ion flux monitoring capability provides a direct correlation with etch and deposition rates.
-  Fundamental-to-harmonic phase output, a key parameter for endpoint detection.
-  All available for pulsed-RF, in both time-resolved mode (1 microsecond resolution) and in pulse-trend mode.

Key Benefits & Applications

-  Equivalent performance to network analyzer and oscilloscope combined, in-line at high power.
-  Advanced endpoint capabilities using plasma impedance and harmonic spectrum analysis.
-  Detect etch endpoints (< 1% open area) with higher sensitivity than multivariate OES endpoint detectors.
-  Live output of ion flux, plasma density and electron temperature is possible (see [Plato Probe](#)).
-  Significant cost benefits through the enablement of fault detection and early intervention.
-  USB, Ethernet, EtherCAT and Serial communication protocols with easy-to-use APIs for integrations.
-  These Advanced applications can be achieved rapidly using the "Impedans Expert" software package and with assistance from Impedans applications team.

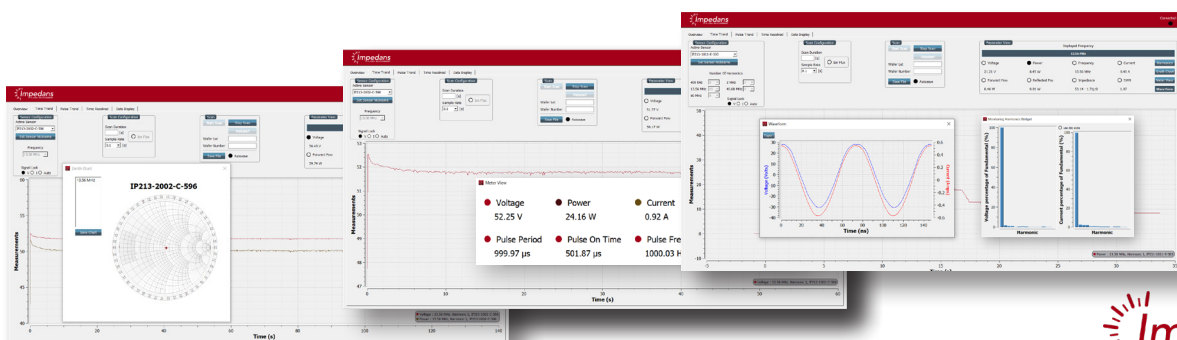

Model Specifications

Model #	Fwd Power Range*	Frequency Range*	Connector Interface
02-0322-01	1.5 W - 12 kW	350 kHz - 240 MHz	QC Type
02-0325-01	0.5 W - 5 kW	40 kHz - 4 MHz	QC Type
02-0312-01	1.5 W - 12 kW	350 kHz - 240 MHz	B6N Multicontact Socket
02-0315-01	1.5 W - 12 kW	350 kHz - 240 MHz	B20N Multicontact Socket
02-0319-01	3 W - 30 kW	350 kHz - 240 MHz	EIA 1-5/8"
02-0321-01	9 W - 90 kW	350 kHz - 240 MHz	EIA 3-1/8"

General Specifications

Calibration Standard	NIST traceable [Power, Impedance]
Calibration Cycle	1 year to maintain quoted accuracy
Sensor Characteristic Impedance	50 Ohms as standard
RF Connectors	QC, EIA and custom options
RF Power Range @ 50 Ohms impedance	Standard: 12 kW typical (connector dependent) High Power: 30 kW & 90 kW
Operating Temperature Range	10° C - 80° C, calibrated versus temperature
Sensor Power Requirements	15-24 V DC, 0.5 A
Communication Interfaces	Micro USB, RJ45x2
Connectivity (Impedans Software)	USB 2.0, Ethernet
Communication Protocols (Standard)	USB 2.0, HTTP Web Service, Serial, RS232
Communication Protocols (OEM Options)	EtherCAT, EtherNet/IP
Parameter Report Rate (Standard)	USB: 500 S/s, Ethernet: 10 S/s, Serial: 10 S/s
Parameter Report Rate (Upgrade Options)	USB: 30 kS/s or EtherCAT: 50 S/s
Sensor Pulse Synchronisation	External sync: TTL input Internal sync: Software level trigger

Power, Voltage & Current Specifications

Power Dynamic Range	> 40 dB
Power Range	See model specifications
Power Resolution	0.25 W
Power Uncertainty (95% confidence)	±1%
Voltage Dynamic Range	80 dB
Voltage Range (Typical)	0.3 V to 3000 V _{RMS} , custom available up to 34 kV _{pk-pk}
Voltage Resolution	0.1 V _{RMS}
Voltage Uncertainty (95% confidence)	±1%
Current Dynamic Range	80 dB
Current Range	2.5 mA _{RMS} to 9 A _{RMS} , custom available up to 500 A _{RMS}
Current Resolution	2.5 mA _{RMS}
Current Uncertainty (95% confidence)	±1%

*Custom options available

Publication list available at: impedans.com/octiv-publications

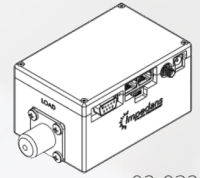

02-0322-01

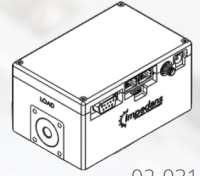

02-0312-01

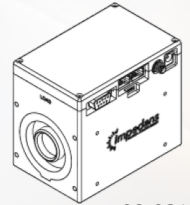

02-0315-01

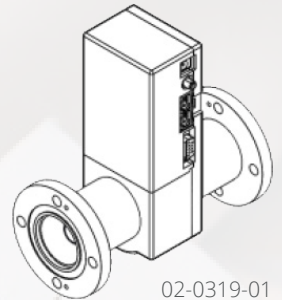

02-0319-01

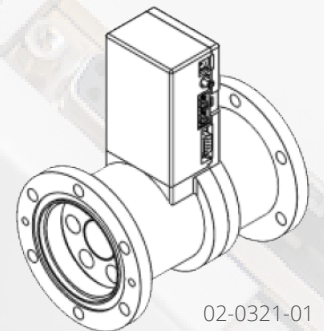

02-0321-01



N Type (M)



N Type (F)

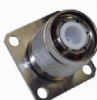

HN (M)



HN (F)



C Type



7/16 (F)



7/16 (M)



LC (F)



LC (M)



EIA (M)



EIA (F)